

# Application Notes

## Vibration Diagnostics for Industrial Electric Motor Drives

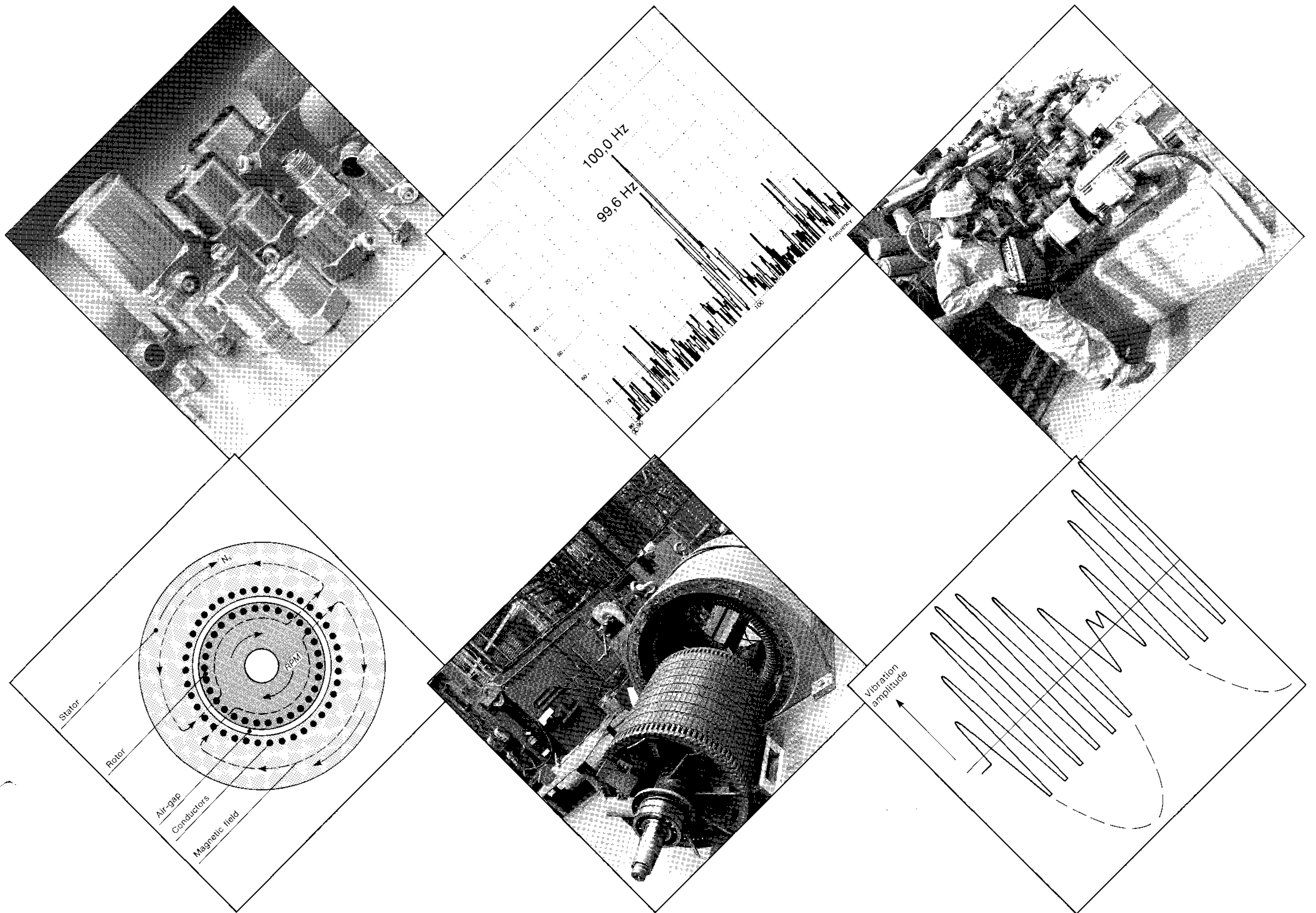

The induction motor is the most widely employed industrial electric-drive. Identifying the vibration problems that can occur in induction-motor drives have an added complexity due to the rotating magnetic-fields in the machine. A basic understanding of the principles involved, together with a simple trouble-shooting guide and the right analysis instrumentation, should be invaluable to the maintenance engineer.

# Vibration Diagnostics for Industrial Electric Motor Drives

by Glenn H. Bate, B.Sc., M.Sc., Dip. UCL. Brüel & Kjær

## Introduction

By far the most widely employed electric motor in industrial drives, is the induction motor and this application note applies to this type of electric motor. Engineers should be able to relate some of the principles to synchronous motors or generators etc., but, for brevity, only the induction motor is specifically discussed. The effects of electronic variable speed drives\* are not discussed either; operation on a mains frequency supply is assumed.

### 'Magnetic' or 'Mechanical'?

The vibration problems relating to the induction motor are a combination of two groups which can be called '*mechanical*' and '*magnetic*', according to how they arise (this is made clear in the following sections).

To help determine which of the two groups of vibration are present, the maintenance engineer can listen for beats. A beat is identified as an oscillatory amplitude of vibration, due to closely spaced frequency components alternately reinforcing then cancelling each other, as their relative phase varies. The absence of beats may indicate there is only a 'mechanical' problem. Their presence can indicate a 'mechanical' problem and 'magnetic' one combined. For example, such components in a 2-pole induction motor, could occur at closely spaced frequencies of twice rotational speed and twice the supply frequency respectively.

Notice that an oscillatory amplitude of vibration also occurs with ampli-

tude modulation of a single frequency component, due to a 'magnetic' problem alone. How amplitude modulation components and beat frequency components can appear in the induction motor is explained later.

More can be discovered about the problem by disconnecting the electric supply (a 'power trip test'). This will distinguish the 'mechanical' and the 'magnetic' components of vibration, since 'magnetic' components will disappear *immediately* after electrical power is removed. The effect of the power trip test should be observed by studying the changing amplitude of the vibration on a spectrum analyzer.

### Spectrum Analysis

Further analysis of the vibration spectra is required to separate out specific faults, and therefore to determine the appropriate rectification action. This can be done using a high resolution spectrum analyzer: typically an FFT (Fast Fourier Transform) analyzer with an increased resolution 'zoom' facility. The resolution is needed to pick out the narrow-band and sideband *signatures* of all the vibration problems occurring with induction motor drives. This application note describes what these signatures are and how or where to find them using the analyzer.

### A Complex Problem

This short application note concentrates on the 'magnetic' problems. The treatment of the 'mechanical' vibration problems relating to the rotating

shaft is brief, concentrating on the results rather than the causes. The 'results' are often seen in association with some of the 'magnetic' vibration problems, because 'mechanical' problems such as unbalance, misalignment and looseness can affect the induction motor magnetic circuit, by causing variations in the air-gap. The problem is further complicated since industrial electric drives are often mounted on rails or box structures as common bases to the driven equipment. This means that measured spectra can contain components due to gearing, bearings etc., transmitted via the structure. Also any spectrum component will vary depending on the mobility of the path from the various vibration sources to each measurement point.

The answer to this complex problem is to identify the specific vibration signatures, and while this application note provides information on only induction motor vibration, Brüel & Kjær are publishing a series of application notes relating to vibrations in shafts, gears, bearings etc..

---

\* Electronic variable speed drives such as d.c. link invertors or cyclo-convertors achieve speed control through synthesis of a varying frequency supply by electronic switching. Due to this, the current supplied has a degree of harmonic distortion, depending on the sophistication of the electronics, filters etc.. The distortion of the current waveform reflects in the vibration spectrum, this relationship is made clear in this application note.

# 'Magnetic' Vibration in Induction Motors

## Principles

The induction machine is shown in simplified form in Fig. 1. Current is produced in the rotor conductors, which is proportional to the difference in speed between the rotating field, produced by the current in the 3-phase stator windings, and the rotor itself. This current produces a rotor field which interacts with the stator field to generate force on the rotor.

The field in the rotor rotates in synchronism with the rotating field in the stator; both advance 2-pole pitches *relative to the stator*, for each cycle of line frequency, i.e. at synchronous speed. The rotor of the induction motor does not rotate at synchronous speed, but instead *slips* backwards through the rotating field. The rate of slip is the difference between synchronous speed and rotor speed.

Since synchronous speed depends on the line frequency and the number of poles in the machine, it is convenient to use the *per-unit* slip as defined in Fig. 1., and define *slip frequency* as per-unit slip  $\times$  line frequency. **This definition of slip frequency applies to all motors regardless of the number of poles.** The slip frequency is the actual frequency of the current in the rotor conductors, and the rotating fields advance *relative to the rotor* by 2-pole pitches for each cycle of slip frequency.

Motor torque is produced where balanced forces exist on either side of the rotor. If the forces of attraction are not balanced, then vibration results. This can be related to current or air-gap variations in induction motors.

## Current Variations Due to Rotor or Stator Faults

Consider a simple coil rotating through a magnetic field as shown in Fig. 2. It is well known that the force on a current carrying conductor in a magnetic field can be obtained from the vector cross product of the current vector and the flux density vector. This can of course be applied to the coil in Fig. 2, but here another more general expression of the force on the coil is given, relating to the total flux  $\Phi$  linking the coil. The relationship given in Fig. 2. shows that the force on the coil, in any arbitrary direction 'x', is directly proportional to the current in the coil and the *rate of change* of the magnetic flux *in the direction of the force* (and *not* the flux itself). The

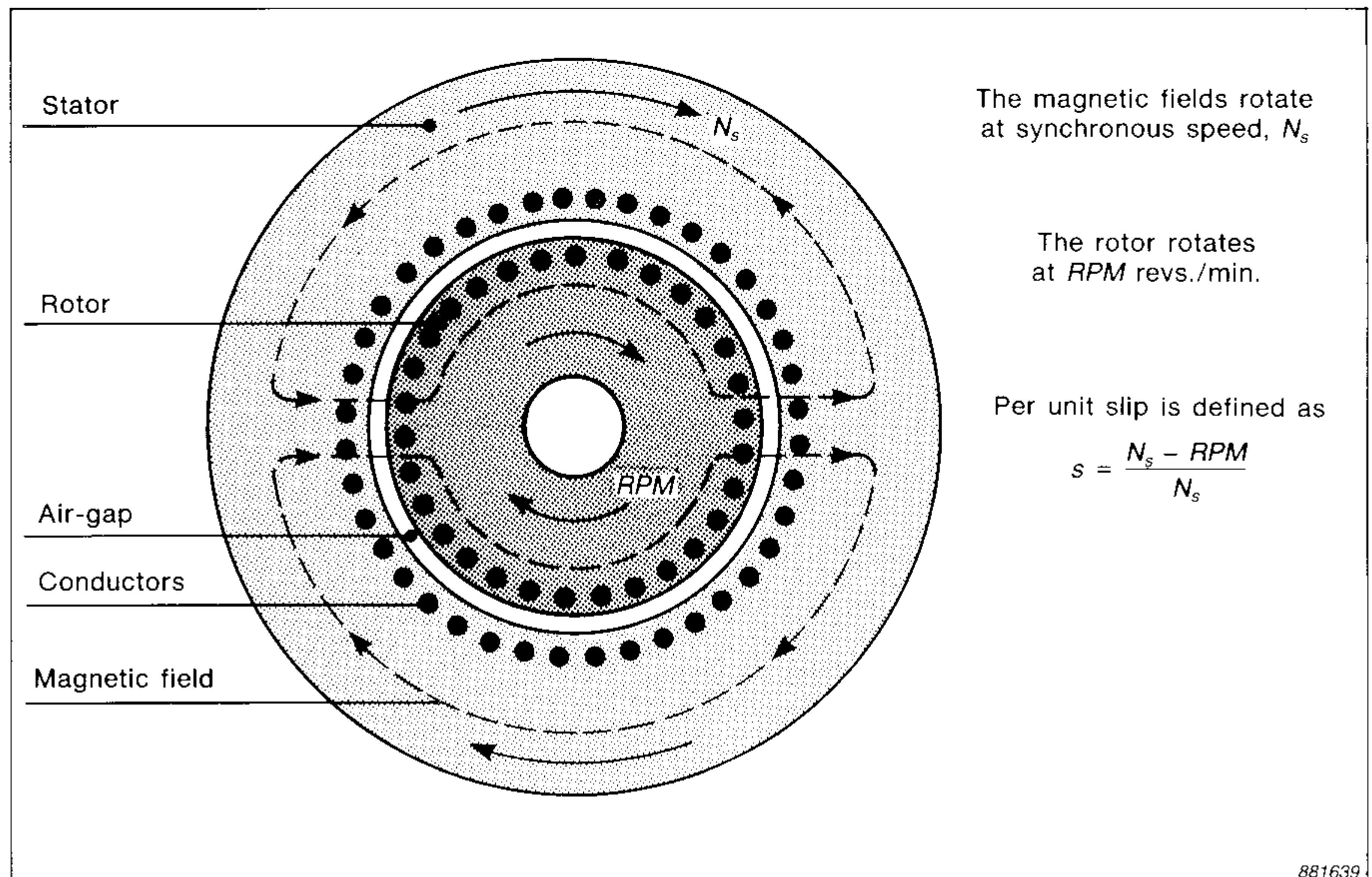

Fig. 1. The induction motor stator, rotor & air-gap

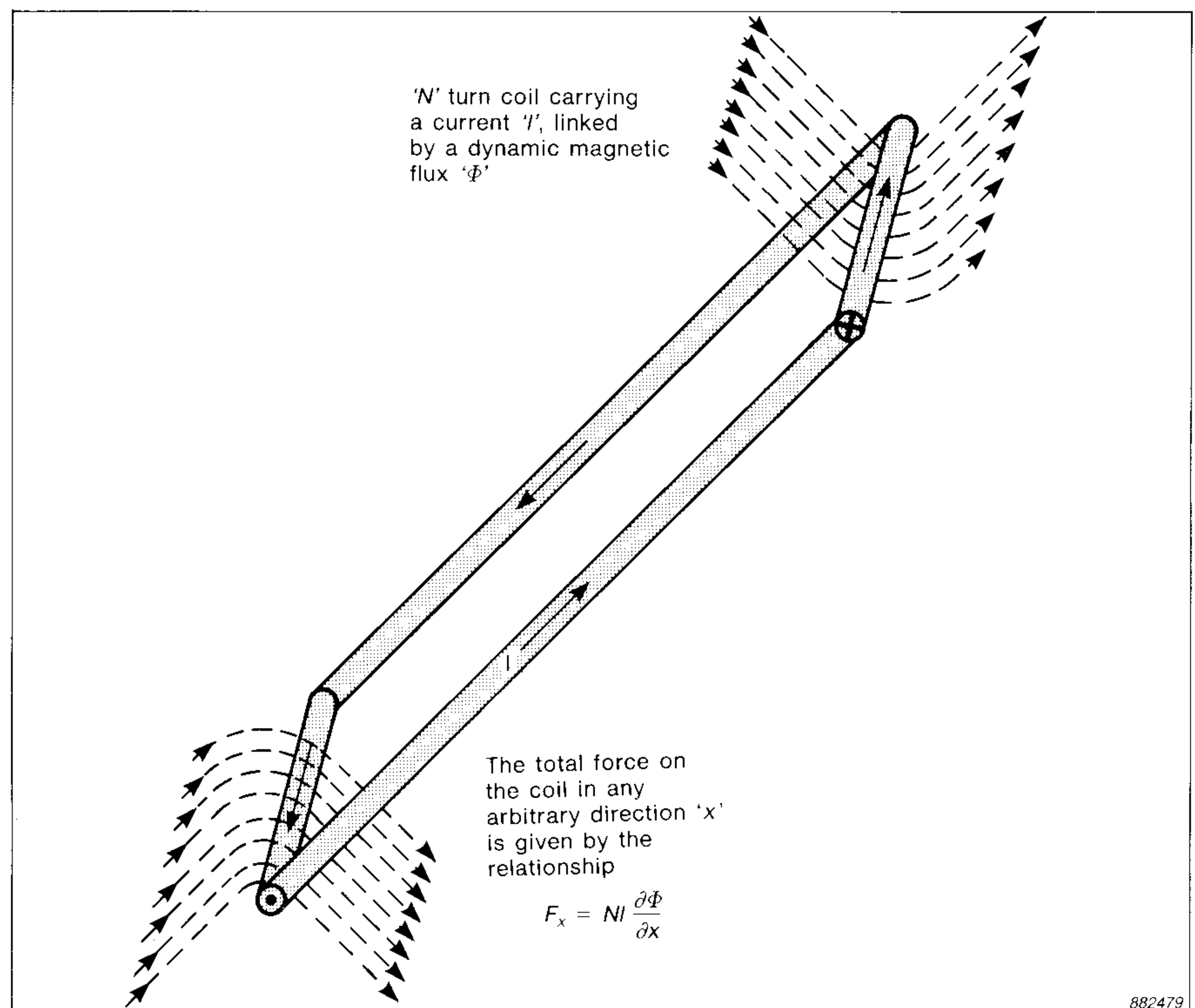

Fig. 2. The force on a current carrying coil moving in a magnetic field

term  $NI$  is called the magnetomotive-force ( $MMF$ ) and the rotating field in the induction motor can be defined as an  $MMF$  wave in the conductors, giving rise to a flux wave in the air-gap. By likening conductors on either side of the rotor to the two sides of the coil, a number of broken bars can be considered as introducing an unbalance of

$MMF$  and thus force between the two sides of the rotor. This force unbalance rotates with the rotor. The equation given in Fig. 2 however, reveals that the force unbalance is obtained from a *multiplication* of the  $MMF$  unbalance and the rate of change of magnetic flux in the direction of the force. If the problem can be simplified by neglect-

ing other than fundamental components of the *MMF* wave, then the unbalance force can be described by the product of two alternating terms of fundamental frequency, but which are not necessarily in phase, of the form:

$$k \sin s\omega t \sin(s\omega t + \theta)$$

or,

$$(k/2)(\cos \theta - \cos(2s\omega t + \theta))$$

where,

$\omega$  = the line frequency

$s$  = the per-unit slip

$k$  = an amplitude value

$\theta$  = a phase angle

i.e. the vibration has a constant part and a  $2 \times$  slip frequency alternating part. Transforming this to a stationary reference frame requires a frequency multiplication of  $1 \times RPM$ . A stationary transducer, positioned for instance on the rotor shaft bearing housing, will therefore measure a vibration with components of  $1 \times RPM$  and  $2 \times$  slip frequency sidebands about a centre frequency of  $1 \times RPM$ .

By similar reasoning, if the current discontinuity is due to a fault in the stator windings, e.g. shorted stator turns, then the resulting force unbalance does not rotate, and is of the form:

$$(k/2)(\cos \theta - \cos(2\omega t + \theta))$$

i.e. The vibration has a constant component and a component at  $2 \times$  line frequency.

### Air-gap Variations Due to Eccentricity

Now consider the relationship given in Fig. 2 with regard to air-gap variations. The flux in the air-gap is generated by the total *MMF* of the magnetic circuit, such that the flux:

$$\Phi = F_m / R_m$$

where,

$F_m$  = the total *MMF*

$R_m$  = the total magnetic reluctance in the circuit

Any eccentricity in the air-gap results in a variation of the magnetic reluctance, which depends on the radial air-gap length. This effect is particularly apparent in induction motors, as these require a very narrow air-gap, compared to synchronous motors or direct current machines. Therefore small defects can result in relatively larger reluctance variations in induction motors.

If the air-gap narrows for instance, then the reluctance decreases and the

same *MMF* will result in greater flux. The travelling sinusoidal flux wave will thus experience a greater rate of change as it enters this region of the air-gap. The effects of a varying air-gap may thus be similar to the effects of current variations. The same relationship for the unbalance force results, where only fundamental frequency components of *MMF* are considered. Static eccentricity refers to an eccentricity which does not travel (e.g. due to bearing wear or misshapen stator), this will produce a vibration force with components at d.c. and  $2 \times$  line frequency. Dynamic eccentricity travels with the rotor (e.g. due to rotor bow), this will produce a vibration force at  $1 \times RPM$  and  $2 \times$  slip frequency sidebands on  $1 \times RPM$ . Indeed these statements are justified by practical results, but consideration of the variation of the reluctance as a periodic function (of space, in the case of static eccentricity, and of time and space, in the case of dynamic eccentricity), suggests different components to look for as the best indication of eccentricity. This is dealt with in the section "Advanced Analysis & Other Techniques" later in this application note.

### 'Rotating' or 'Stationary'?

The 'magnetic' problems discussed so far, can also be classified as either a 'rotating' or a 'stationary' problem, according to the vibration produced. A presentation of this with some typical causes is given in Table 1.

### Frequency Modulation Due to Speed Variations

The discontinuities in the magnetic forces of attraction giving rise to vibration as discussed, also cause variations in motor torque. Depending on

the inertia constant of the rotor shaft, some speed variation may result. The speed variation will be larger for low inertias, and this can therefore cause a frequency modulation of the vibration components whose frequency is referenced to rotor speed. For high inertias the speed variation and therefore the degree of frequency modulation will be less.

Where sidebands are generated then, the general case is somewhere between pure amplitude modulation and frequency modulation. The spacing between each sideband component is still the modulating frequency, however, in the case of frequency modulation the number of sidebands can be much greater than two, depending on the modulation index, i.e. the ratio of the peak frequency (or speed) deviation to the modulating frequency (or the frequency of the torque variations). See Fig. 3.

### Slot Frequencies

The slots carrying the conductors in the induction motor, also generate a vibration force as they create unbalanced magnetic forces of attraction, resulting from an effective variation of reluctance in the magnetic circuit as a function of the rate of stator and rotor slot passing. The components will be present in a 'healthy' motor of course, since the slots are part of the design, and these will always tend to concentrate the magnetic field in the slot teeth rather than the slot channel, due to higher magnetic permeability in the material in the teeth than in the conductors in the channels. The vibrations occur at the frequencies given by the equation in Fig. 4, which represents the principal harmonic content of the resulting force function.

Type of Problem	Symptomatic Frequency of Vibration	Typical Cause	
		Air-gap Variations	Current Variations
Stationary	$2 \times$ line frequency	Static eccentricity, weakness of stator support	Stator winding faults
Rotating	$1 \times RPM$ with $2 \times$ slip frequency sidebands	Dynamic eccentricity Loose rotor bar(s)	Broken or cracked rotor bar(s), or shorted rotor laminations

Table 1. 'Rotating' and 'stationary' magnetic vibration in induction motors

T01892GB0

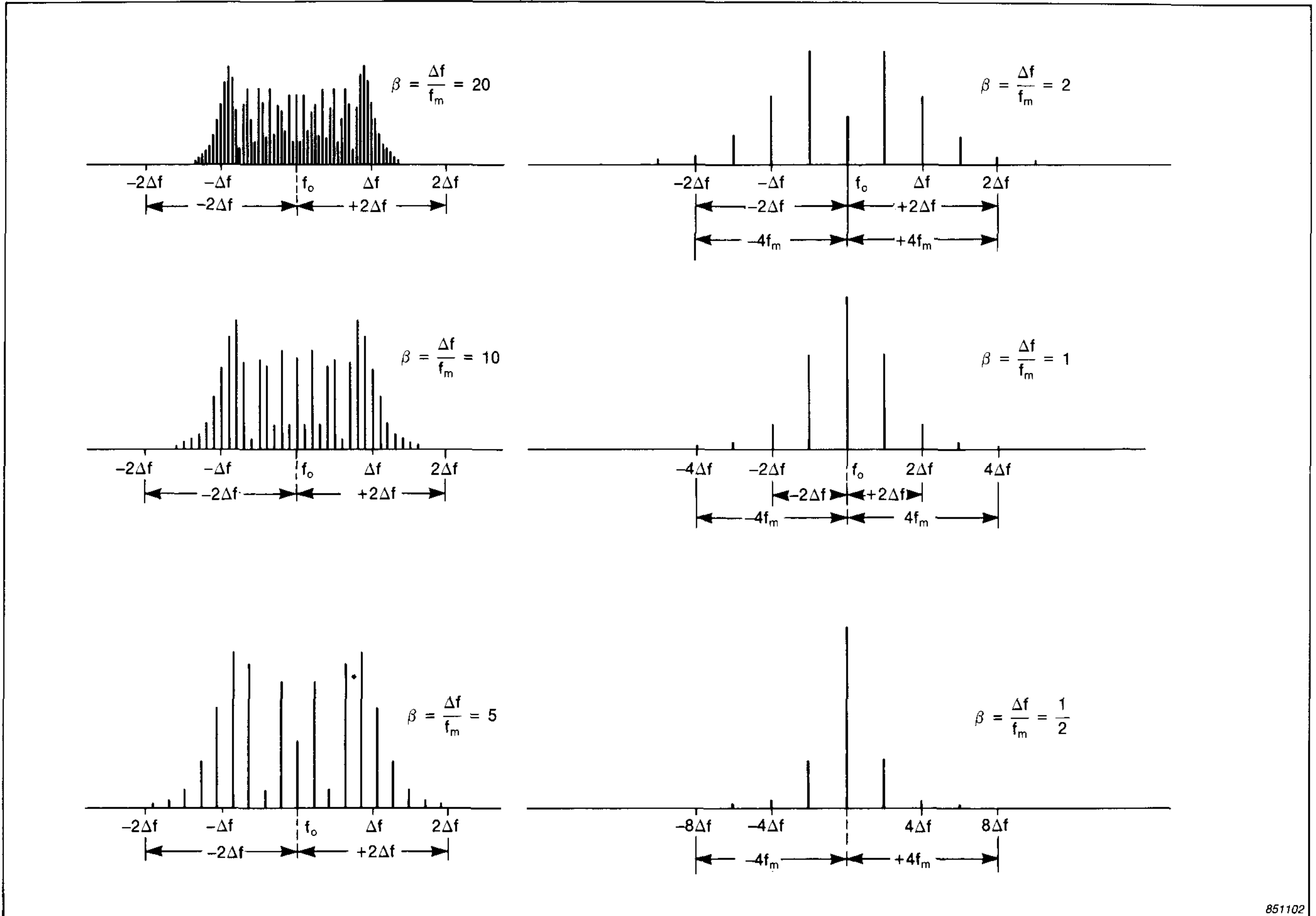

Fig. 3. Amplitude spectra of sidebands for frequency modulation with various values of modulation index  $\beta$

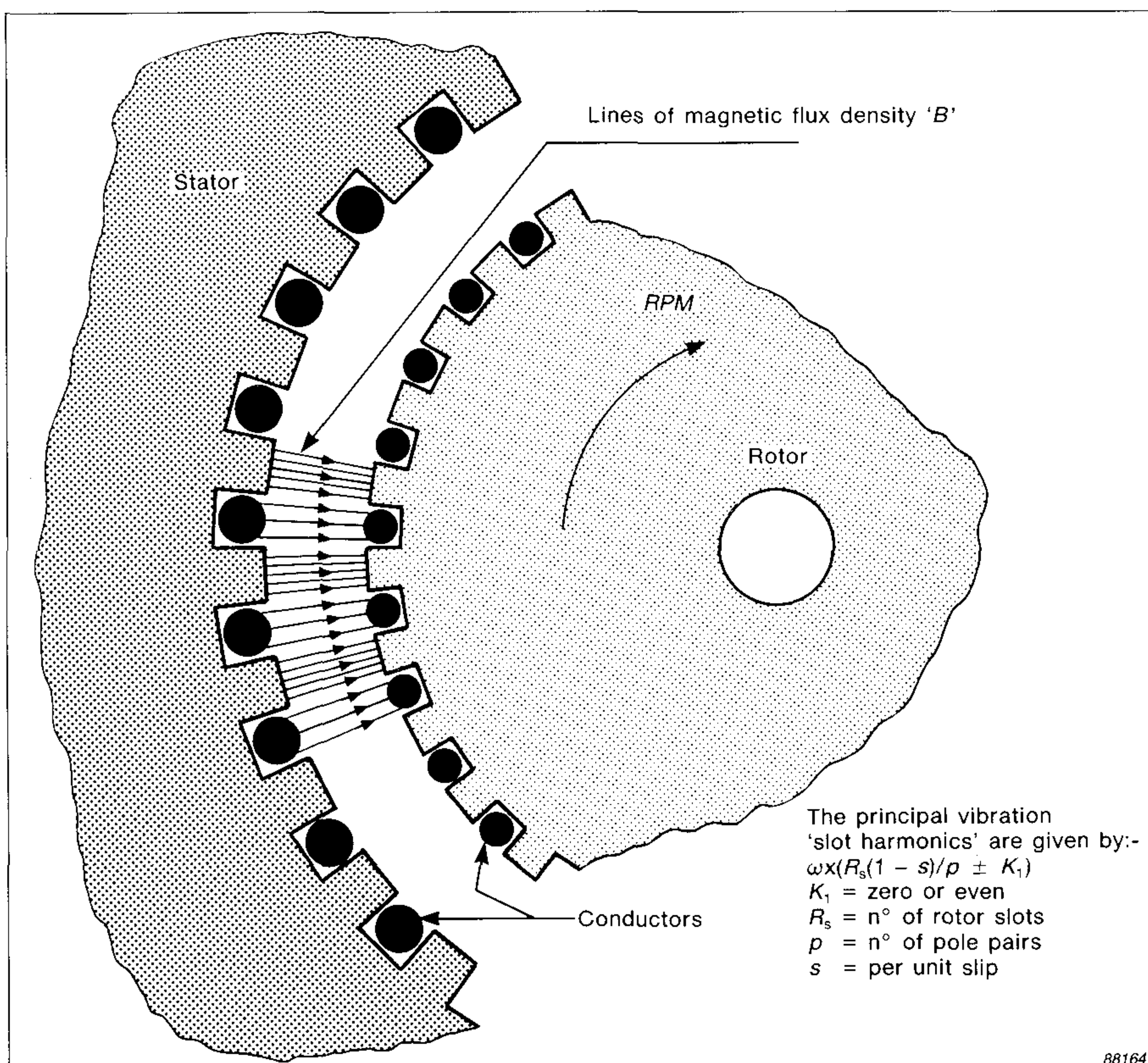

Fig. 4. Illustration of how the stator and rotor slots distort the magnetic field, concentrating lines of flux density in the air-gap over the slot teeth

## The 'Mechanical' Vibration Problems of the Rotating Shaft

A brief description of the 'mechanical' vibration problems resulting from faults occurring on the rotating shaft is appropriate, since these problems are often interdependent with 'magnetic' vibrations as described already. For a thorough treatment of shaft and bearing vibrations, please ask your Brüel & Kjær representative for application notes on these subjects.

### 1 ×, 2 × RPM

A guide to the most common shaft vibrations and causes is given here. This is presented in tabular form in Table 2. From this it can be seen that a 1 × RPM component of vibration force may arise from a number of fault conditions. Misalignment and bent shafts can be separated from unbalance by ascertaining if a large vibration component at 2 × RPM is present; this component does not arise in the case of unbalance. To distinguish a bent shaft and different forms of misalignment, identifying the pre-

dominant plane of vibration (whether axial or radial), and the relative phase of the vibration between the two ends of the shaft is the key. Phase can also be used to distinguish types of unbalance, as indicated in Table 2.

Immediately it is apparent that a  $1 \times RPM$  component can arise from many causes, both 'mechanical' and 'magnetic', and for a 2-pole induction motor,  $2 \times$  line frequency and  $2 \times RPM$  are very close especially on light load (low values of slip).

### Truncation

Where truncation of a vibration signal occurs in the time domain, the spec-

trum in the frequency domain is characterized by a large number of harmonics, and possibly sub-harmonics of the fundamental component. Such a spectrum can result from mechanical looseness, where the harmonics are of  $1 \times RPM$ . Truncation may also arise in cases of misalignment, and also stiffness non-linearities. In the case of the induction motor rotor and shaft, this may lead to a more complicated analysis, especially if truncation of a beat vibration occurs, see Fig.5. This will induce strong components at the sum and difference frequencies of the two frequency components of the beat, say  $\omega_1$  and  $\omega_2$ , and also compo-

nents at  $(2\omega_1 + \omega_2)$  &  $(2\omega_1 - \omega_2)$ . Additionally these components will have sidebands separated by the difference frequency  $(\omega_2 - \omega_1)$ .

In a 2-pole induction motor, this difference will be equal  $2 \times$  slip frequency when the beat frequencies are  $2 \times$  line frequency 'magnetic' vibration and  $2 \times RPM$  'mechanical' vibration!

### Bearings

Bearings in induction motors can be of the rolling element type, but for larger machines they are usually the sleeve type. In rolling element bearings, local faults produce a series of impacts which can excite resonances in the structure of the bearing housing and the machine casing. These resonances are typically between 1 kHz and 20 kHz. The actual fundamental frequencies associated with the impact repetition rates given in Fig.6 are sometimes seen, but are generally low in level and so lost in the background\*. Problems associated with sleeve type bearings that give frequency components in the range of interest for the induction motor problems discussed so far, are due to oil whirl and whip. These can give components at a fraction (0.43 to 0.48) of  $1 \times RPM$ .

Type of Problem	Dominant Frequency	Dominant Plane	Phase Relationship <sup>(3)</sup>
Unbalance	$1 \times RPM$	Radial <sup>(2)</sup>	Static Unbal. - $0^\circ$ Couple - $180^\circ$ Rad. Dynamic - $0 \rightarrow 180^\circ$
Bent Shaft or Misalignment (Angular)	$1 \times, 2 \times^{(1)} RPM$	Axial	$180^\circ$ Axial <sup>(4)</sup> $0^\circ$ Radial
Misalignment (Parallel)	$1 \times, 2 \times^{(1)} RPM$	Radial	$180^\circ$ Radial $180^\circ$ Axial <sup>(4)</sup>
Mechanical Looseness	$1 \times, 2 \times RPM^{(5)}$	Radial	Variable

T01662GB0

- (1) A high  $2 \times$  component can be expected, depending on the magnitude of the problem and the system mobility
- (2) For overhung rotors the axial component is often dominant, but axial vibration is always present with a couple
- (3) The phase relationship given is the approximate phase difference measured from shaft-end to shaft-end
- (4) Accelerometers placed at each end of the shaft may be oriented in opposite directions, thus giving a measured phase relationship of  $0^\circ$  for an actual  $180^\circ$  relationship
- (5) Higher harmonics and also interharmonics of  $1 \times RPM$  i.e.  $0.5 \times 1.5 \times RPM$  etc. can often be present, resulting from the non-linearity caused by truncation

Table 2. Rotating shaft 'mechanical' vibration problems

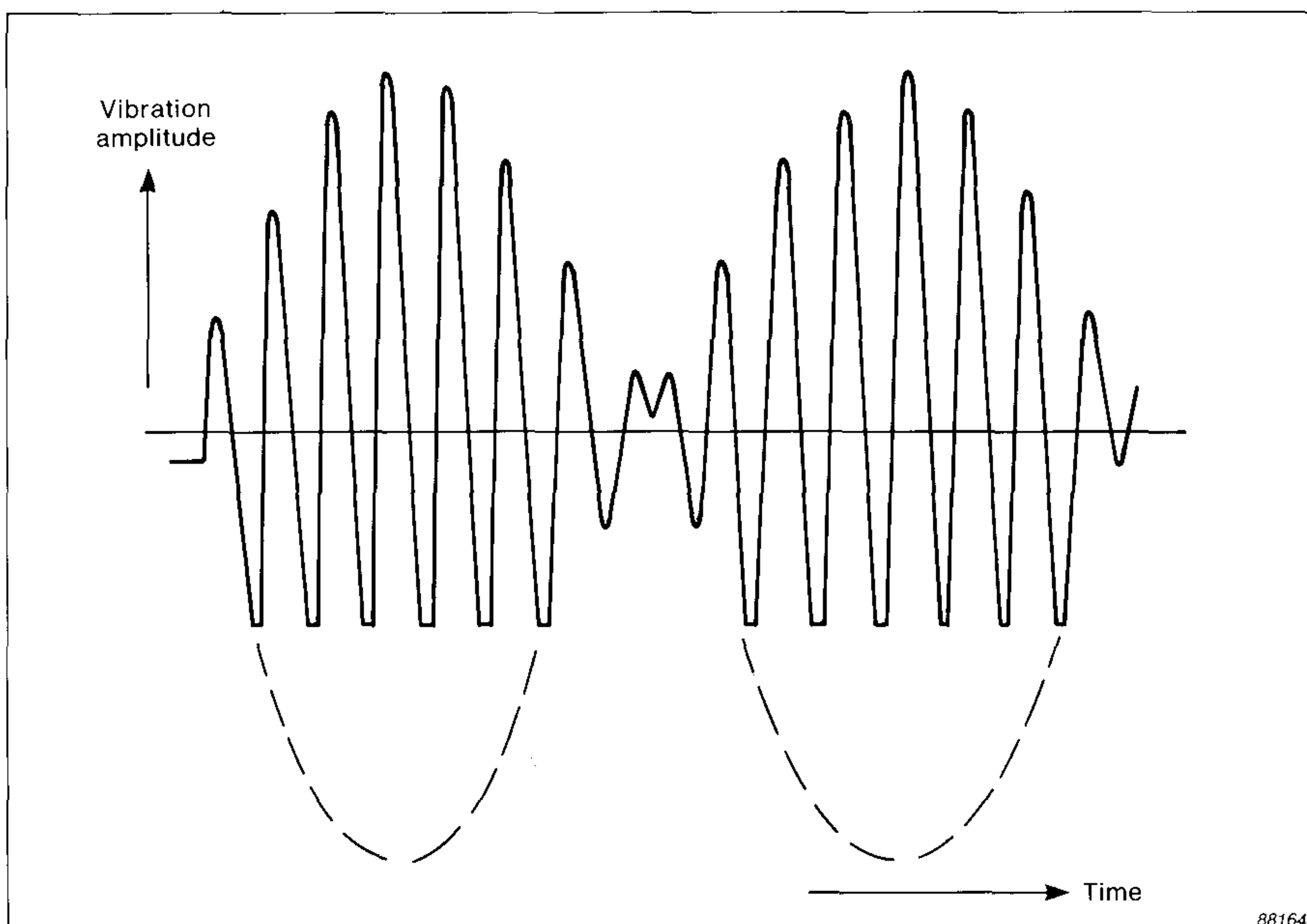

Fig. 5. A beat vibration amplitude waveform that is truncated

\* Envelope analysis on a resonance region in the spectrum excited by the bearing faults, can recover the fundamental impact rates for accurate diagnosis

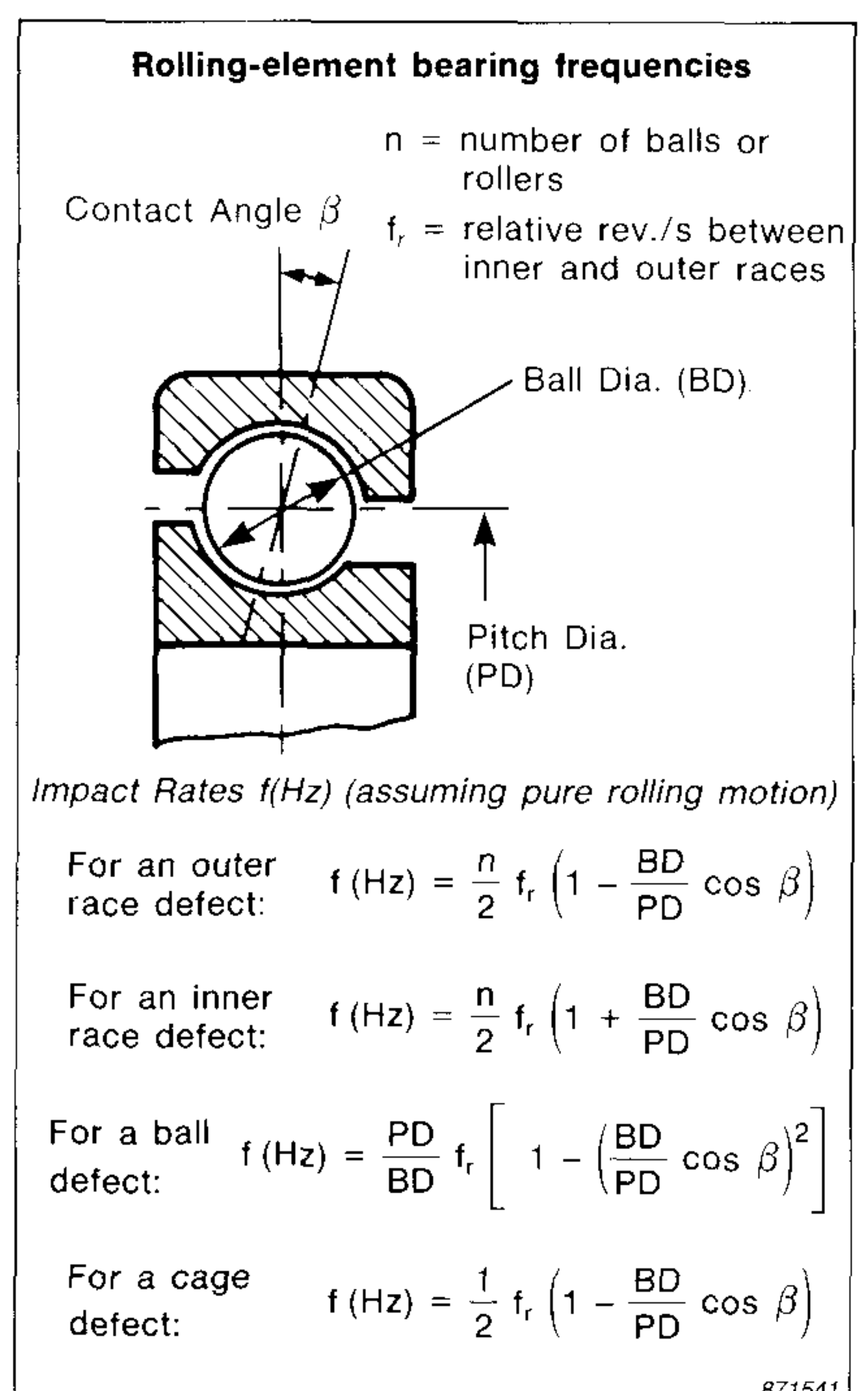

Fig. 6. Formula for calculating rolling-element bearing frequencies

## Practical Trouble-shooting

The discovery of any of the above vibration signatures in a spectrum on a spectrum analyzer does not necessarily imply that there must be a problem requiring immediate rectification. There will always be some 'magnetic' or 'mechanical' imperfections in any motor, so the question arises: What is a problem? Standards do exist, like ISO 2372 (and equivalent national standards), by which the severity of vibration levels can be judged. Whilst it is useful to know these, they are often far too crude to judge whether a particular problem will result in breakdown, or is otherwise intolerable in the particular operating environment. For instance, broken rotor bars in an induction motor can cause arcing, which is highly dangerous in explosive or inflammable environments.

### Spectrum Increases

By far the most effective means of determining whether a problem exists is spectrum comparison of a current vibration spectrum and the spectrum of the machine in good condition. Increases in frequency components or the appearance of new components are the best indicator that something is going wrong.

### CPB and Narrow-band Analysis

Where spectrum comparison forms part of a regular maintenance programme, a package such as Brüel & Kjær's Type 2515 Vibration Analyzer (an FFT Spectrum analyzer) and Type 7616 Application Software on an IBM personal computer, automates the comparison process, based on constant percentage bandwidth (CPB) spectra\*. This is ideal for detecting a developing fault, but for actual diagnosis, use of the Type 2515's capability for narrow-band constant bandwidth 'zoom' analysis is necessary. This is required to pick out the narrow-band and side-band signatures of the 'magnetic' vibration problems and distinguish these from 'mechanical' vibrations. An illustration of this is given in Fig. 7, where a constant bandwidth spectrum shows a single peak at around 100 Hz, but the 'zoom' around this component identifies that it is in fact two components, one at 99.6 Hz, the other at 100 Hz. The spectrum given is from a 2-pole induction motor driven screw

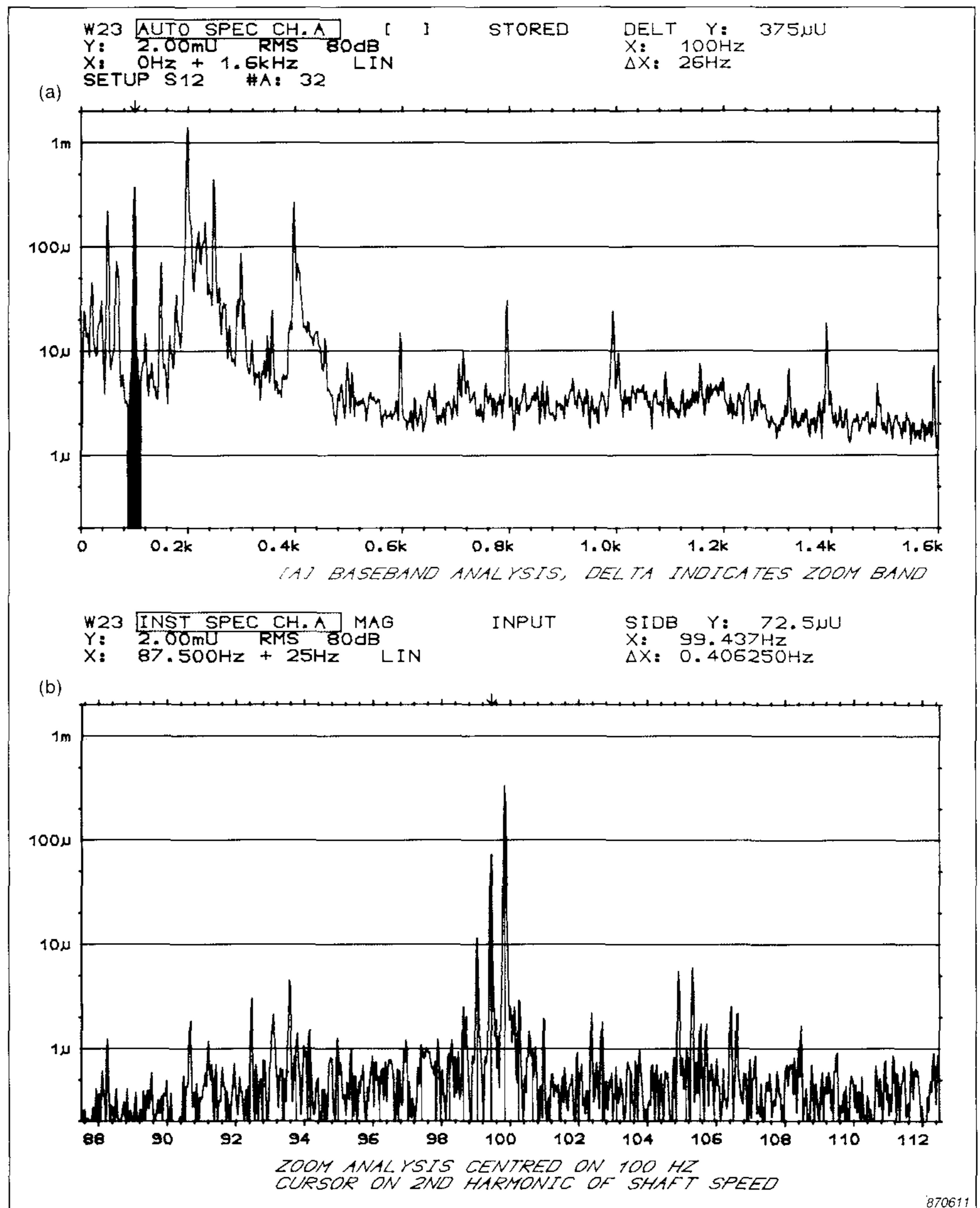

Fig. 7. Narrow-band vibration components due to 'magnetic' & 'mechanical' problems, separately identified using 'zoom' analysis

compressor, and the two peaks in question are  $2 \times RPM$  and  $2 \times$  line frequency components respectively.

### Fault Prognosis

As mentioned, eccentricity 'problems' may be present in a healthy motor, and whether they represent any cause for concern may be determined by comparing with broad-band vibration standards and applying engineering judgement for particular operating conditions. 'Fault' development or progression can be followed by observing changes in the narrow-band signa-

tures. If levels don't increase there may be no cause for concern, but if regular monitoring shows increases, then a problem is developing. Trending the increases may help decide when the fault must be corrected, but this must be based on experienced judgement. Eccentricity problems can occur together with mechanical problems, as a result of poor installation, or machining or other problems after an overhaul.

Broken rotor bars are obviously not present in a healthy motor, and their occurrence is in any case an immedi-

\* CPB frequency analysis is a powerful tool in detecting general machinery faults as a broad spectrum can be covered while still maintaining resolution at the lower frequencies where it is generally required. For instance a 6% CPB spectrum has a resolution of 60 Hz at 1 kHz in the spectrum and 6 Hz at 100 Hz in the spectrum.

ate problem, regardless of environment, since the damage will be progressive, with adjacent bars eventually breaking. This is due to higher thermal and mechanical stresses in the adjacent bars, as they are forced to carry more current. This progression will depend on many factors, including motor age and duty cycle. Long starting and heavy start-stop duty cycles

normally cause the stresses that result in broken bars in the first place.

### Positioning the Transducer

The measurements made depend very much on the positioning of the transducer, due to the mechanical mobility of the motor structure, as has already been stressed. A further practical point is also worth mentioning to aid

the reader seeking the best positioning of the transducer: travelling radially around a motor casing, the transducer may pass through "valleys" and "troughs" of the measured vibration amplitude, due to the casing response to the driving vibration force. Differences of eg. 20 dB in rms level are not uncommon.

## Advanced Analysis & Other Techniques

The problem that is immediately apparent from Table 1, is that there are a number of 'magnetic' faults resulting in the same vibration signature. The discrimination is only between 'stationary' and 'rotating' problems. Further analysis or other differences in signature are needed to distinguish between current and air-gap variations, broken rotor bars and a rotating air-gap eccentricity for instance. Unfortunately, research being carried out to achieve this, is still in infancy.

### Non-fundamental Components

The simple explanation of the the 'magnetic' vibrations given earlier assumed an *MMF* wave with only the fundamental frequency component. The reality of course is rather different. Since there is a strong discontinuity in the current in bars surrounding a broken rotor bar, or in the region of an air-gap variation, the resulting *MMF* wave is strong in harmonics. The slot frequency components are also present, so inspection of the relationship in Fig. 2 shows that the resultant vibration force will contain all the components arising from the cross-products of the fundamental wave with itself and its harmonics and with the slot frequency components.

Some researchers (see the list of references at the end of this application note), have carried out an analysis of the theoretical flux density wave due to the effects of slotting, eccentricity, saturation effects and the fundamental stator *MMF*. They have predicted and confirmed experimentally, level changes in the principal vibration slot harmonics as a result of static eccentricity, and the appearance of new components around the slot harmonics as a result of dynamic eccentricity. Frequencies predicted are given by:

$$\omega \times [(nR_s \pm k_e) \times (1 - s)/p] \pm k_1]$$

where,

$\omega$  = line frequency

$n$  = any integer

$R_s$  = number of rotor slots

$k_e$  = an eccentricity 'order', zero for static eccentricity and a low integer value for dynamic eccentricity

$s$  = per-unit slip

$p$  = number of pole-pairs

$k_1$  = zero or even

Further work is trying to predict the relative magnitudes of these components as a function of eccentricity. This will mean limits for these vibration components can be set for acceptable eccentricity in a motor.

It has been claimed by these researchers, that these components are unique to eccentricity. However, the comparison, for instance, of the vibration spectrum around the principal slot harmonics, for a healthy motor and one with broken rotor bars, shows the appearance of new components as well as 'slip' sidebands on the principal slot harmonic. As explained, this is due to the *MMF* wave being rich in harmonics, due to the current discontinuity at the broken bar, but it also shows that, even if analysis shows some differences between broken rotor bars and dynamic eccentricity, determining these differences on practical measurements will still have to be proven. Until this is the case, engineers must rely on their experience and judgement, to decide which is the more likely fault.

### Other Techniques

There are a number of other techniques that have been put forward to monitor 'magnetic' faults in induction motors. Principally, the monitored parameters suggested are: Motor Speed, Axial Flux (using search coils), and Stator Current (using a clip-on current transformer on the supply). Since current (or *MMF*) and flux are inter-

related, and force (and motor torque) and hence speed, depend on the product of *MMF* and rate of change of flux, all these measure essentially the same thing as vibration, which is of course a measure of force. A consensus of opinion seems to have been reached between researchers and industry, that monitoring stator current or vibration are preferred, since these techniques are non-invasive, i.e. they require no modification to the motor and can be performed without interrupting operation.

Stator current analysis is also performed using a spectrum analyzer. However, rather than using an accelerometer or proximity probe, as in vibration measurements, a clip-on current transformer is employed. Proponents of current analysis seem to have concentrated on detecting broken rotor bars, and this is indeed a common and important fault in induction motors. The analysis method used is the detection of 'slip' sidebands on the line frequency component of stator current, similar to those sidebands on  $1 \times RPM$  in the vibration spectrum. The effect of eccentricity, and whether this can be differentiated from broken rotor bars using this method, does not seem to have been addressed yet. The main advantage of current analysis however, is that the degree of damage, i.e. the number of broken rotor bars, can be estimated from the absolute magnitude of the sideband components, taking a number of other experience based factors (data) into consideration. This is not practical in the case of vibration analysis, since the magnitude of the measured components depends so much on the mechanical mobility of the particular transmission path, between the source of the vibration and the point at which the transducer is placed. Notice two points though: Firstly, there are cer-



tain theoretical configurations in which rotor bars could break, where current analysis would not detect the fault, but vibration analysis would. Secondly, vibration analysis is already employed to detect a wide variety of problems in rotating machinery, for which current analysis is irrelevant.

## Final Notes and Conclusions

This application note has shown that vibration analysis is capable of detecting and distinguishing between 'mechanical' and 'magnetic' faults in induction motor drives. Of particular interest has been the detection of the 'magnetic' faults. These can be distinguished as arising from either a 'stationary' or a 'rotating' problem. Further distinguishing between possible

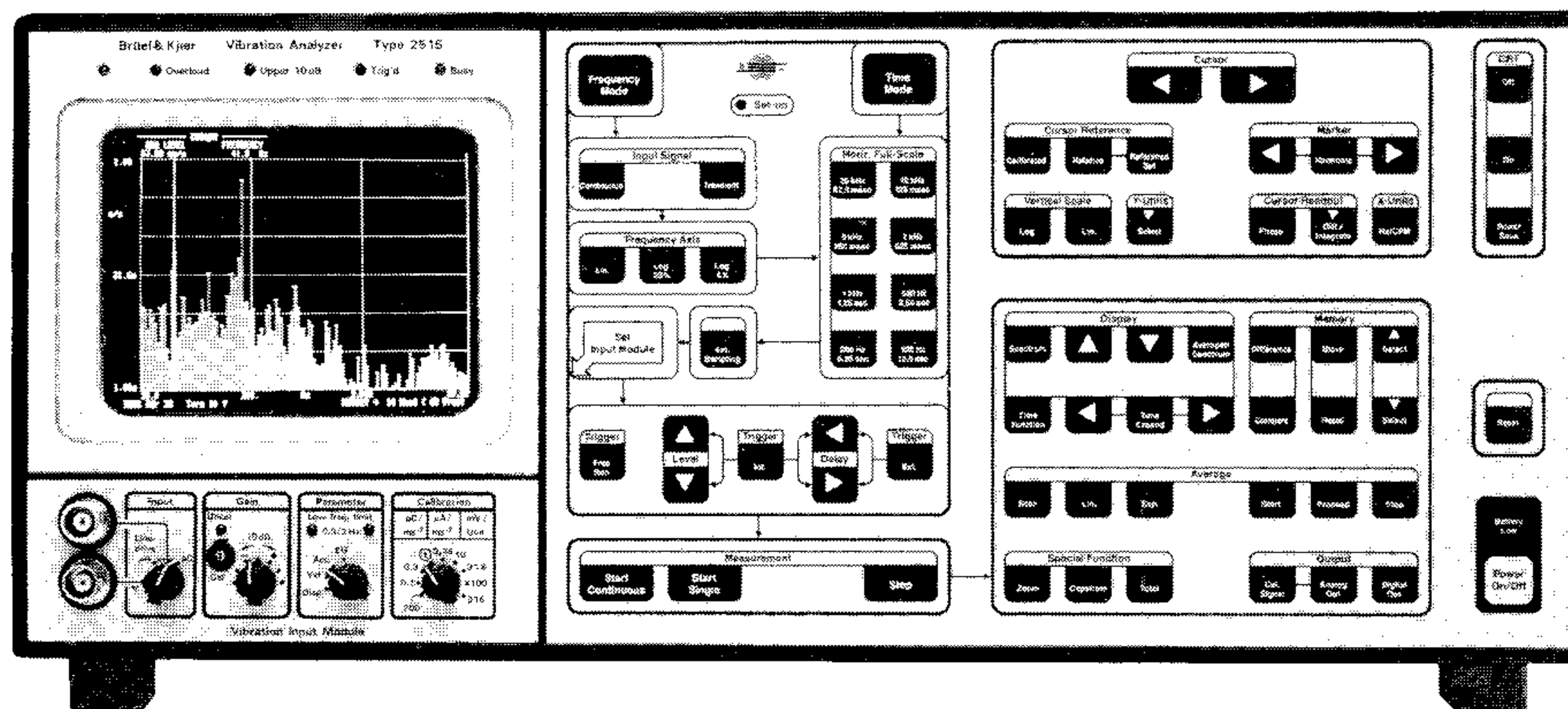

Fig. 8. The Type 2515 Vibration Analyzer. (An advanced portable single channel FFT analyzer that features a built-in preamplifier for direct connection of accelerometers)

winding faults or eccentricity problems is not so clear-cut and further research is needed to ensure the accuracy of interpretation. This also applies to the technique of stator current

analysis. As a final 'trouble-shooting' guide, Table 3 is a presentation of all the vibration components dealt with in the text and the possible causes, but also gives some components that have

Vibration Cause	Symptomatic Frequency	Dominant Plane	Comment
<b>Unbalanced Rotor Shaft</b>	$1 \times RPM$	Radial	Type of unbalance can be determined from phase relationships (see Table 2)
<b>Bent Shaft or Angular Misalignment</b>	$1 \times, 2 \times RPM$	Axial	See Table 2 for more information
<b>Parallel Misalignment</b>	$1 \times, 2 \times RPM$	Radial	See Table 2 for more information
<b>Mechanical Looseness</b>	$1 \times, 2 \times, 3 \times, 4 \times RPM$ etc. also $0,5 \times, 1,5 \times RPM$ etc.	Radial	High number of harmonics and possible interharmonics characterizes truncation
<b>Damaged Rolling Element Bearings</b>	Induced resonance in the bearing housing and machine casing in the range 1 to 20 kHz typically	—	Resonance is excited by impacts of local faults in the bearing. Also frequencies due to fundamental impact repetition rates (see Fig.6), which are generally lost among other signals + noise at lower frequency however
<b>Oil Whirl and Whip in Sleeve Bearings</b>	$0,43 \text{ to } 0,48 \times RPM$	Radial	Sleeve Bearings are common in larger motors
<b>Static Eccentricity</b>	$2 \times$ line frequency and components at $\omega \times [nR_s (1-s)/p \pm k_1]$	Radial	Can result from poor internal alignment, bearing wear, or from local stator heating <sup>1)</sup> (Vibration worsens as motor heats up)
<b>Weakness/Looseness of Stator Support, Unbalanced Phase Resistance or Coil Sides, Shorted Stator Laminations/Turns</b>	$2 \times$ line frequency	Radial	Referred to as "loose iron" Difficult to differentiate between this group using only vibration analysis, but they will also be apparent at no load as well as on load
<b>Loose Stator Laminations</b>	$2 \times$ line frequency and components spaced by $2 \times$ line frequency at around 1 kHz <sup>†</sup>	Radial	Can have high amplitude but not usually destructive. The high frequency components may be similar to static eccentricity <sup>†</sup>
<b>Dynamic Eccentricity</b>	$1 \times RPM$ with $2 \times$ slip frequency sidebands and components at $\omega \times [((nR_s \pm k_e) \times (1-s)/p) \pm k_1]$	Radial	Can result from rotor bow, rotor runout, or from local rotor heating <sup>2)</sup> (Vibration worsens as motor heats up)
<b>Broken or Cracked Rotor Bar, Loose Rotor Bar, Shorted Rotor Laminations, Poor End-Ring Joints</b>	$1 \times RPM$ with $2 \times$ slip frequency sidebands and components similar to those given above for dynamic eccentricity <sup>†</sup>	Radial	The slip sidebands may be low level, requiring a large dynamic range as well as frequency selectivity in measuring instrumentation. Typical spectra are shown in the appendix showing that these components in the region of the principal vibration slot harmonics also have slip frequency sidebands

1) Local stator heating may be caused by shorted laminations

2) Local rotor heating can be caused by shorted laminations or broken or cracked rotor bar(s)

† Observed components (see main text)

Table 3. A trouble-shooting guide as a summary of all the induction motor vibrations discussed in the application note

been observed (identified with a †), the validity of which is not specifically established in the theoretical analysis, and so must be confirmed or rejected by experience of maintenance engineers in the field.

### Expert Systems

The experience of engineers in the field can be partly reproduced by collecting a computer based data base, in a system using this and other programmed knowledge (such as the trouble-shooting guide), then designing inference procedures, to result in an 'expert system'. Such systems have already been applied, apparently successfully, to the diagnosis of electric motor problems using vibration analysis (see references). As research continues and remaining questions are answered, expert systems must have an important role to play. The current state of the art however, as this application note makes clear, means that a knowledgeable and experienced maintenance engineer is probably best equipped to assess a complex problem.

It is hoped that this application note helps such engineers.

### The Importance of Power

This final note is of extreme importance to the problem of practical measurements. As can be seen from consideration of the relationship given in Fig. 2, forces and thus vibration magnitudes, vary according to the square of current. Thus the *magnitudes are load power dependent*; at high load powers the current in the motor conductors is higher. Also per-unit slip, even for a motor on normal load is typically 0.03 to 0.05, i.e. a small value. On light loads therefore, not only will the magnitude of vibration components be lower, but the spacing of sidebands will be even smaller. In such circumstances it may be necessary to use an analyzer with greater dynamic range and frequency resolution, such as the Brüel & Kjær Types 2033 or 2032/34 single or dual channel analyzers. The worst case is a motor running freely, then the per-unit slip is typically 0.005. Note also that a varying load

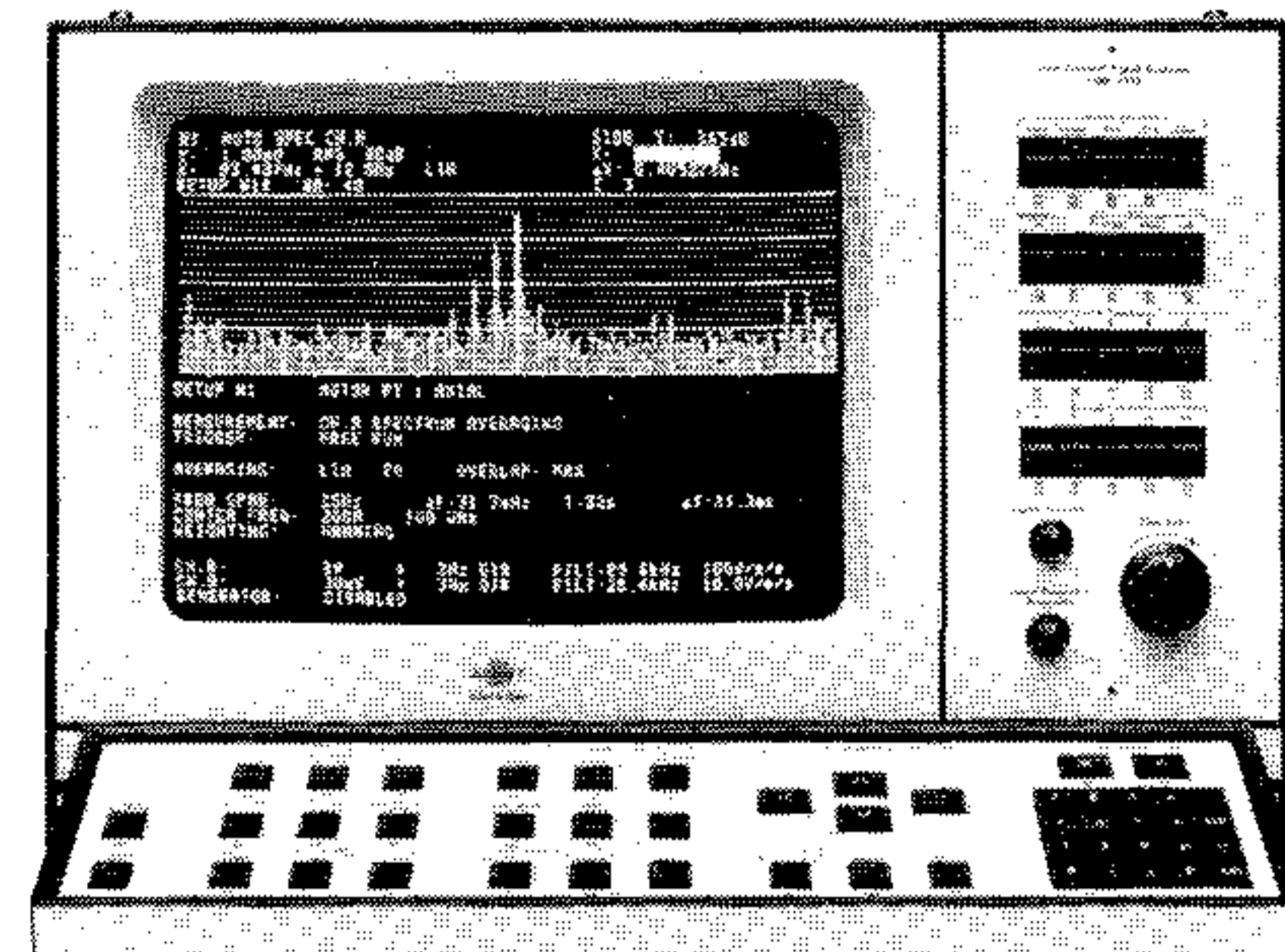

Fig. 9. The Type 2032 Dual Channel Signal Analyzer. (Features truly extensive post-processing)

problem could make analysis very difficult. Measurement transducers are also very important, especially when measuring low level signals. The unique Delta Shear<sup>®</sup> design of Brüel & Kjær accelerometers makes them particularly insensitive to environmental influences which might otherwise distort the vibration signal and give false readings or obscure important signatures.

## References

- [1] J.R. Cameron, W.T. Thompson, A.B. Dow, "Vibration and current monitoring for detecting air-gap eccentricity in large induction motors", Proc. IEE, Vol. 133, Pt. B, № 3, May 1986, pp 155-163.
- [2] J.E. Corley, G.D. Darby, "Development and implementation of an expert system to diagnose motor vibration problems", Proceedings Of The Fifteenth Turbomachinery Symposium, 1986, pp 111-118.
- [3] H.M. Conolly, R.J. Jackson, I. Lodge, I. Roberts, "Detection of interturn faults in generator rotor windings using air-gap search coils", Proc. of Int. Conf. on Electrical Machines - Design and Applications, IEE, London, Conf. Publ. 254, September 1985, pp 11-15.
- [4] R.L. Eshleman, "The role of sum and difference frequencies in rotating machinery fault diagnosis", I Mech E, England, publ. C272/80, 1980, pp 145-149.
- [5] B.G. Gaydon, "An instrument to detect induction motor circuit defects by speed fluctuation measurements", Testmex Conf., IEE, Wembley 1979, Conference Publ. 174, pp 5-8.
- [6] C. Hargis, B.G. Gaydon, K. Kamash, "The detection of rotor defects in induction motors", Proc. Int. Conf. on Electrical Machines, Design and Applications, IEE, London, May 1982, Publ. 213, pp 216-220.
- [7] J.H. Maxwell, "Induction motor magnetic vibration", Proc. Vibration Institute, Machinery Vibration Monitoring and Analysis Meeting, Houston, Texas, Apr. 19-21, 1983.
- [8] J. Penman, M.N. Dey, A.J. Tait, W.E. Bryan, "Condition monitoring of electrical drives", IEE Proc, Vol. 133, Pt. B, №3, May 1986, pp142-148.
- [9] J. Penman, J.G. Hadwick, B. Barker, "Detection of faults in electrical machines by examination of the axially directed fluxes", Third Int conf. on Elec. Machines, Brussels, 1978.
- [10] J. Penman, J.G. Hadwick, A.F. Stronach, "Protection strategy against the occurrence of faults in electrical machines", Proc. of second Int. Conf. on Developments in Power System Protection, IEE, London, Conf. Publ. 185, June 1980, pp 54-58.
- [11] R.B. Randall, "Frequency analysis", Brüel & Kjær, Denmark, 1987.
- [12] P.J. Tavner, B.G. Gaydon, D.M. Ward, "Monitoring of generators and large motors", IEE Proc, Vol. 133, Pt. B, №3, May 1986, pp169-180.
- [13] P.J. Tavner, J. Penman, "Condition monitoring of electrical machines", Research Studies Press, Letchworth, Hertfordshire, England, John Wiley & Sons INC., 1987.

[14] W.T. Thomson, D. Rankin, "Case histories of on-line rotor cage fault diagnosis", Conf. Condition Monitoring '87, Dept. Mech. Eng., University College Swansea, Pinerich Press, Mumbles, Swansea, UK.

[15] D. Traver, D. Foley, "Diagnosing gear and motor problems with signature analysis", ASME Publ. DE-7, 1987, pp 39-45.

[16] S. Williamson, A.C. Smith, "Steady state analysis of three-phase cage motors with rotor-bar and end-ring faults", IEE Proc., Vol. 129, Pt. B., No3, May 1982.

## Appendix

A series of figures is presented here depicting the identification of broken rotor bars using taped vibration signals recorded on a Brüel & Kjær Type 7005 Portable Instrumentation Tape Recorder. In accordance with the main text and Table 3 in particular, two spectral regions are concentrated on—the region around the motor speed ( $1 \times RPM$ ) and the region around the principal slot harmonics.

The motor concerned has 2 pairs of poles and 28 rotor slots. It is running at 24.875 Hz from a nominal 50 Hz supply, the first principal vibration slot harmonic is just over 696 Hz. Three rotor bars in the motor are broken.

A Brüel & Kjær Type 2032 Dual Channel Signal Analyzer was used to perform FFT frequency analysis; spectra, cepstra and envelope spectra were plotted on a Type 2319 Graphics Plotter, directly from the Type 2032.

The first two figures show the identification of the motor speed and slip frequency sideband components in a baseband spectrum to 50 Hz (Fig. A1) and the corresponding cepstrum (Fig. A2). The remaining four figures show the baseband spectrum to 1.6 kHz (Fig. A3), a "zoom" on this spectrum around the second principal slot harmonic (Fig. A4), the corresponding cepstrum (Fig. A5), and finally, the envelope spectrum from a

third octave filter centred on 800 Hz (Fig. A6). The figures illustrate the presence of the motor speed ( $1 \times RPM$ ) and the  $2 \times$  slip frequency sidebands and the modulation of the principal vibration slot harmonics by these components. The cepstra of Fig. A5 identifies particularly clearly the motor speed sidebands on the principal vibration slot harmonics. That these sidebands also have their own slip frequency sidebands can be seen on the zoom spectra in Fig. A4 and the envelope spectra of Fig. A6.

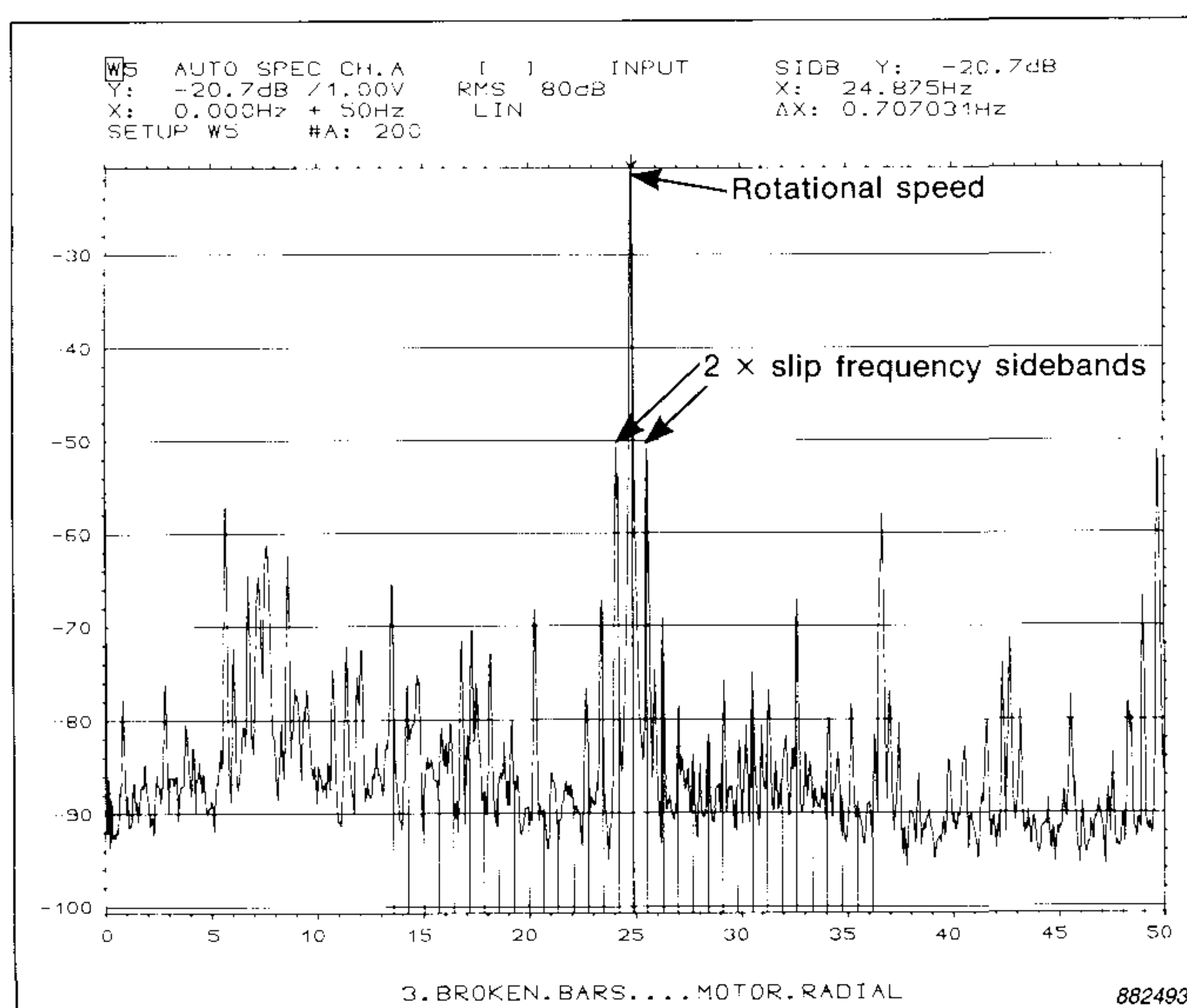

Fig. A1. Baseband spectrum to 50 Hz showing the motor rotational speed component with  $2 \times$  slip frequency sidebands

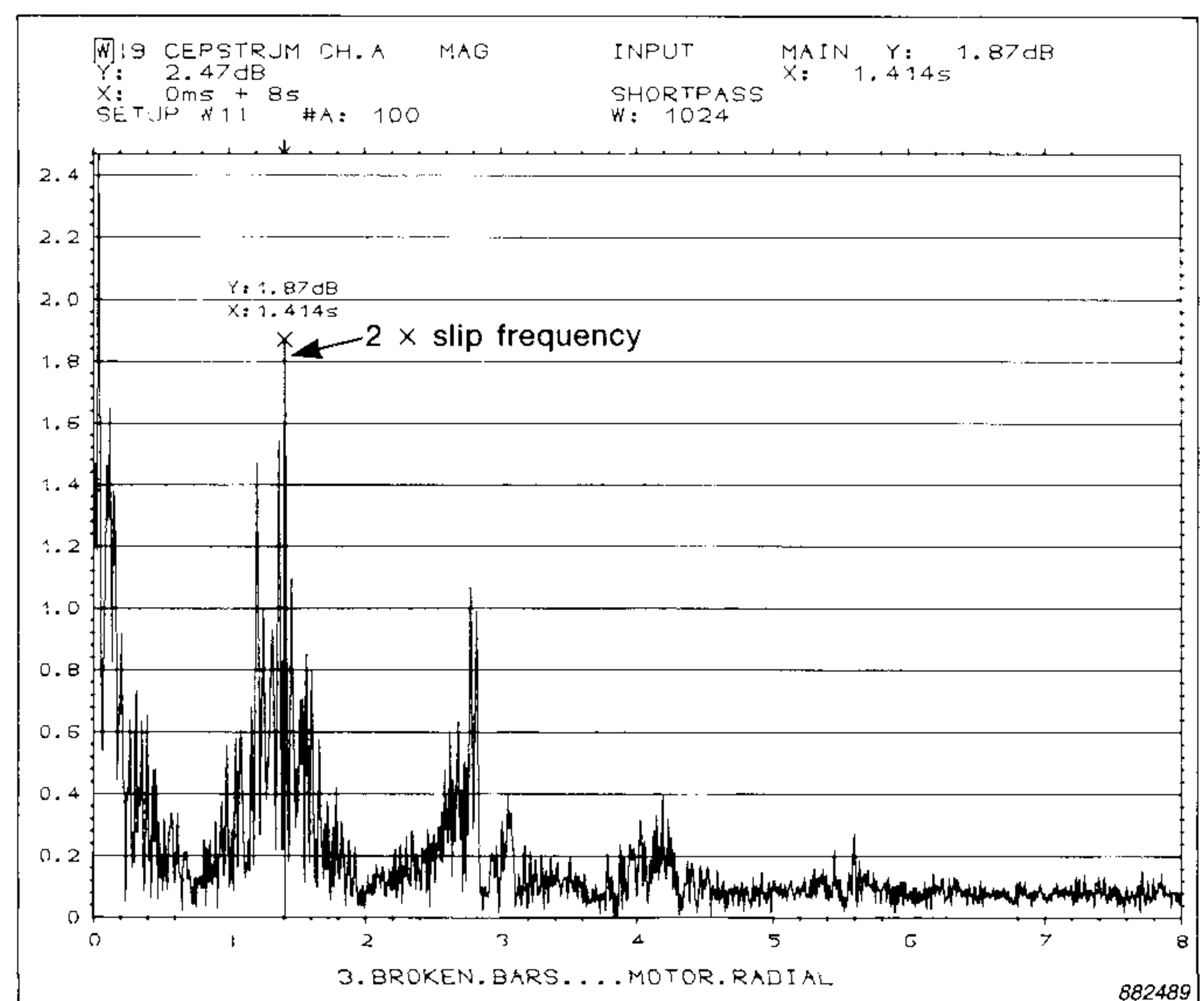

Fig. A2. Cepstrum of the baseband 50 Hz spectrum showing the peak at  $2 \times$  slip frequency

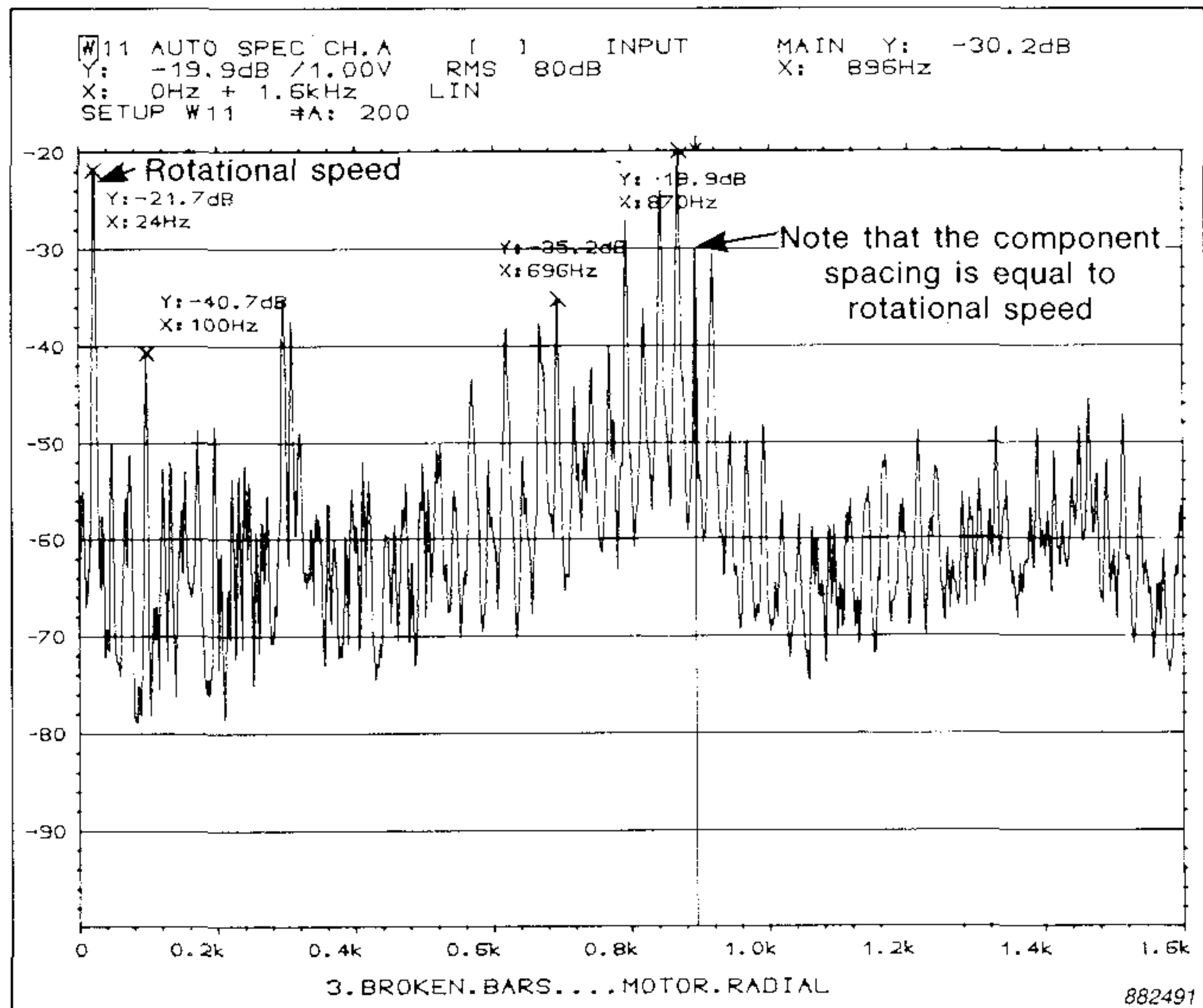

Fig. A3. Baseband spectrum to 1.6 kHz showing both the motor speed component and the region around the principal vibration slot harmonics

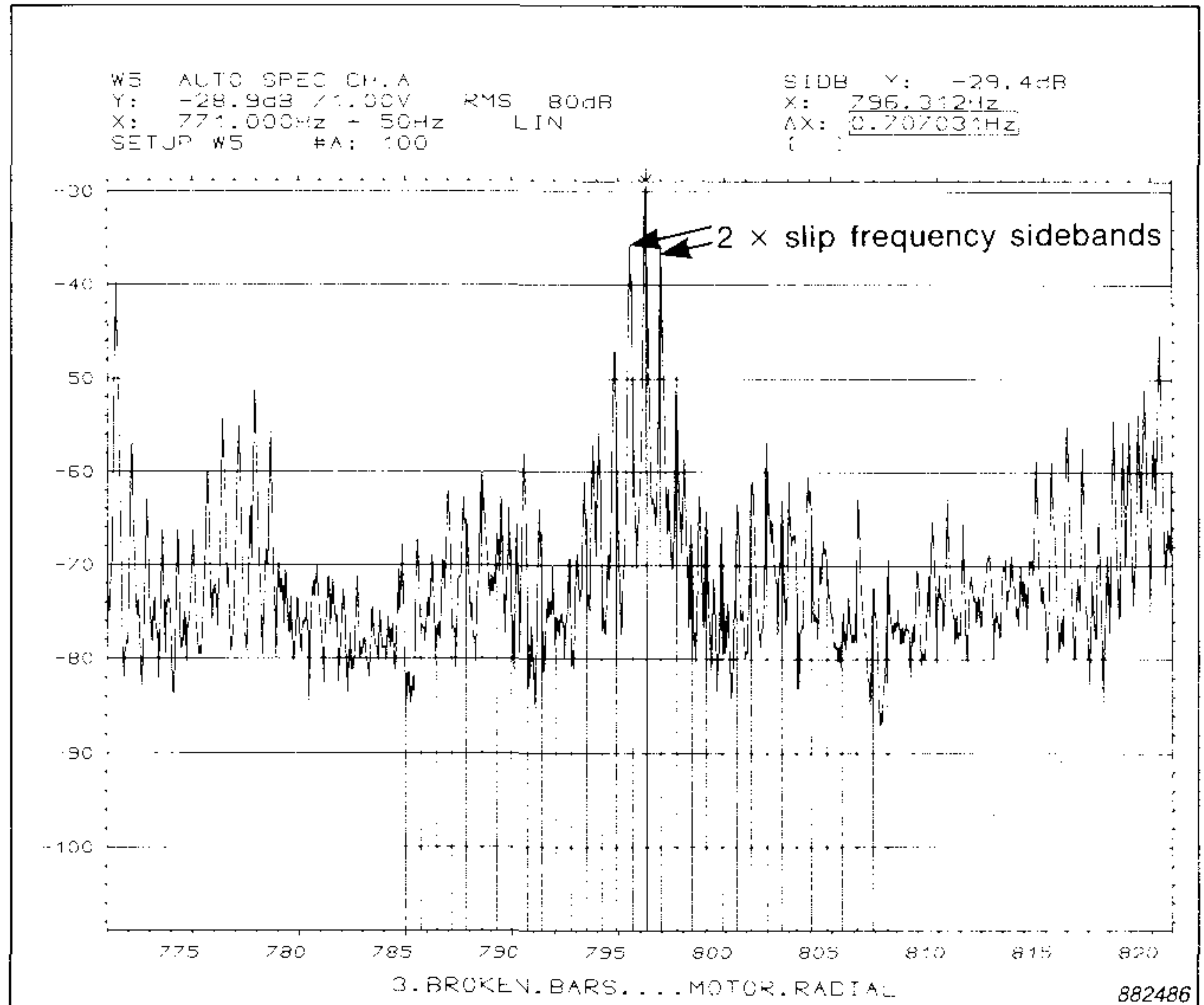

Fig. A4. Zoom spectrum centred around the second principal vibration slot harmonic, showing 2 x slip frequency sidebands on the component at this frequency

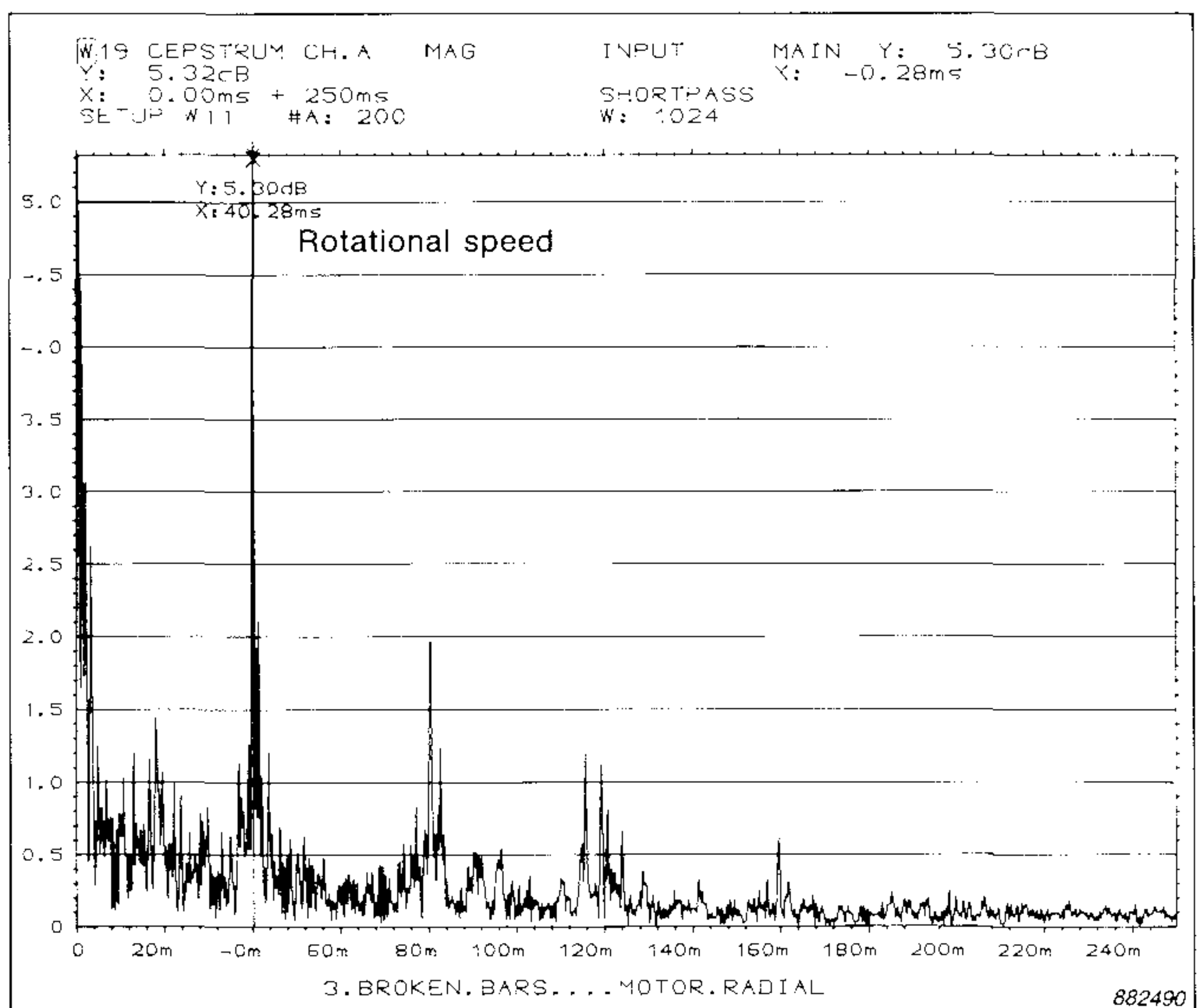

Fig. A5. Cepstrum of the 1.6 kHz baseband spectrum, clearly identifying the motor speed (1 x RPM) periodicity in the baseband spectrum

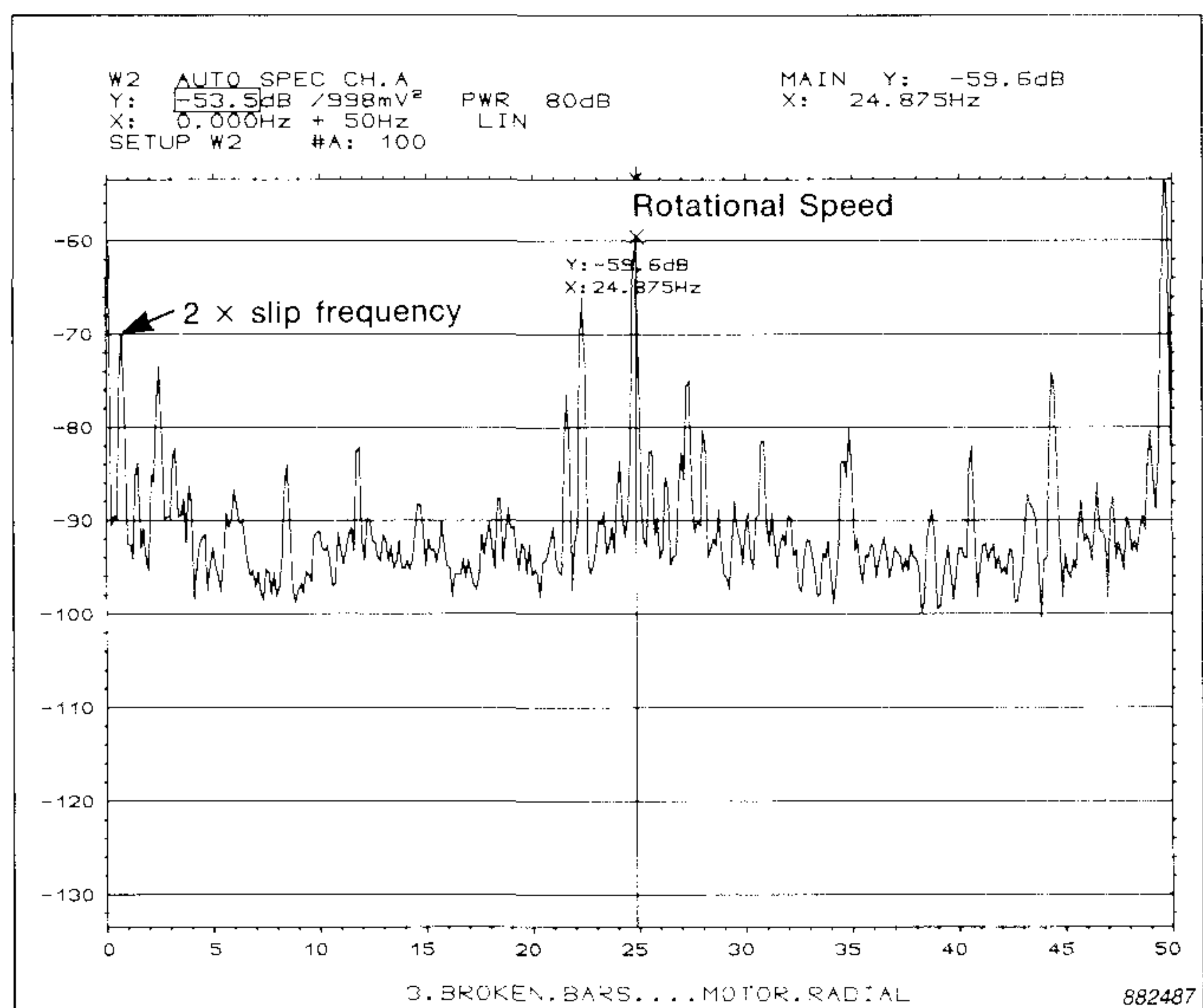

Fig. A6. Envelope spectrum from a third octave filter centred on 800 Hz, showing not only the (1 x RPM) modulation present in the region of the principal vibration slot harmonics, but also the 2 x slip frequency modulation